

Folding boxes EQ - with grip opening, with ribbed base

EQ64321R | Data sheet

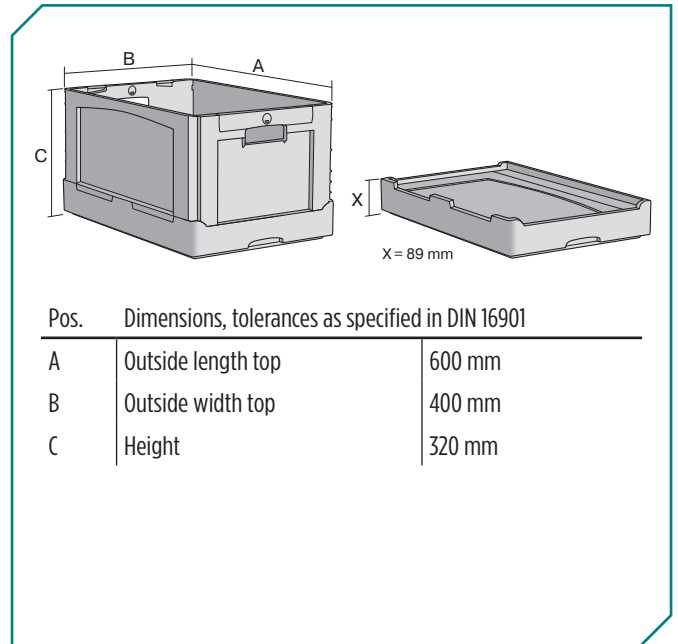
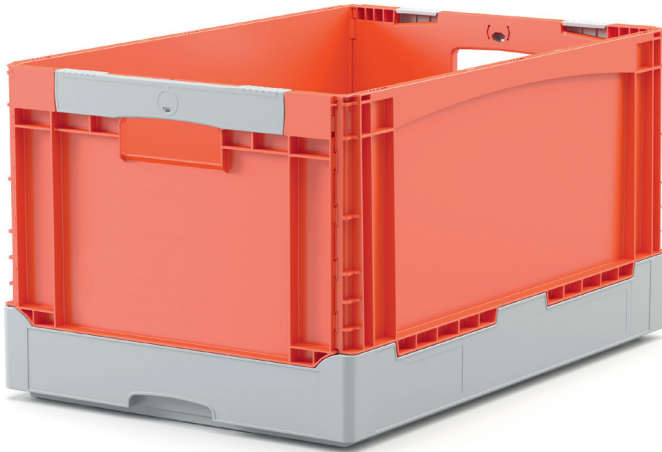

Product features	*Load capacity as specified in EN 13117
Weight	2.82 kg
*Stacking load	180 kg
*Load capacity	50 kg
Volume	62 litres
Warranty	5 year BITO QUALITY
ESD	No
Temperature range	-20°C to +80°C
Food safety	✓
Material	PP
Stock item	-
Pcs/pack	1
colour	orange/grey
Ref. no.	51-31461

Other colours / special colours on request

Dimensions, tolerances as specified in DIN 16901	
Outside length top	600 mm
Outside width top	400 mm
Height	320 mm
Inside length top	568 mm
Inside width top	368 mm
Inside length base	566 mm
Inside width base	366 mm
Inside height	302 mm

Information & Service
www.bito.com

BITO
 STORAGE
 SYSTEMS

Folding boxes EQ - with grip opening, with ribbed base

EQ64321R | Accessories



Transport dollies
polypropylene wheels
L 620 x W 420 mm
43-1491



Security seals with laser marking
suited for BITO folding boxes EQ
51-31666



Document pockets
self-adhesive
3 sides open
L 175 x W 105 mm
6-5031