

Multi-purpose containers MB, for hazardous substances, drop-on lid with metal snap locks

MBSG43321CLIP | Data sheet

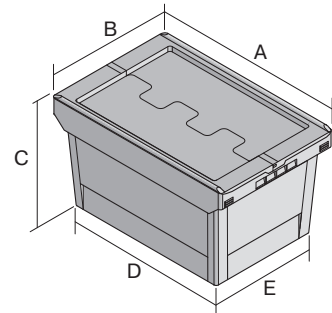

Pos. Dimensions, tolerances as specified in DIN 16901

Pos.	Dimensions, tolerances as specified in DIN 16901	
A	Outside length top	410 mm
B	Outside width top	310 mm
C	Height	338 mm
D	Base length outside	318 mm
E	Base width outside	240 mm

Product features	*Load capacity as specified in EN 13117
Weight	1.95 kg
*Load capacity	13 kg
Volume	27 litres
ESD	No
Food safety	-
Material	PP
Stock item	✓
Pcs/pack	1
colour	purple red
Ref. no.	6-18655

Other colours / special colours on request

Dimensions, tolerances as specified in DIN 16901	
Outside length top	410 mm
Outside width top	310 mm
Height	338 mm
Inside length top	349 mm
Inside width top	271 mm
Inside length base	313 mm
Inside width base	235 mm

Information & Service
www.bitto.com

BITO
STORAGE
SYSTEMS

Multi-purpose containers MB, for hazardous substances, drop-on lid with metal snap locks

MBSG43321CLIP | Accessories



Security seals

MBP1 - suited for BITOBOX MB
6-10810

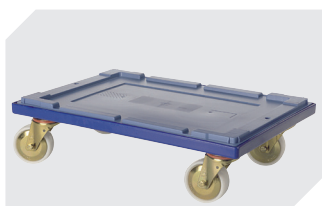

Transport dolly

for multi-purpose containers sized
600 x 400 mm
L 620 x W 420 mm
6-15510

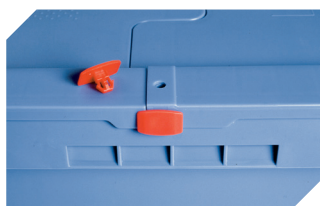

Security seals

MBP2 - suited for BITOBOX MB
6-15705



Security seals

MBP2-L - suited for BITOBOX MB,
XL, SL
6-19162



Transport dolly

for multi-purpose containers sized
800 x 400 mm and 800 x 600 mm
L 720 x W 540 mm
6-19439



Locking clips

suited for BITOBOX MB
6-20299



Barcoded security seals

MBP3 - suited for BITOBOX MBs in all
sizes and XLs 800 x 600 mm
6-31550