

Small parts containers KLT with double base, with hinged two-part lid
KLTD64420D | Data sheet

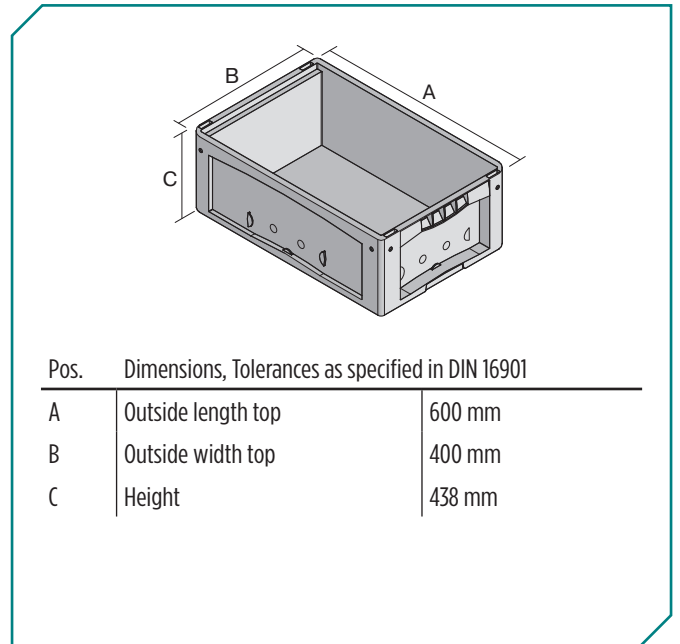

Product features	*Load capacity as specified in EN 13117
Weight	4.93 kg
*Stacking load	500 kg
*Load capacity	75 kg
Volume	74 litres
Warranty	5 year BITO QUALITY
ESD	ESD version upon request
Temperature range	-20°C to +60°C
Food safety	✓
Material	PP
Stock item	✓
Pcs/pack	1
colour	turquoise
Ref. no.	9-17515

Dimensions, Tolerances as specified in DIN 16901	
Outside length top	600 mm
Outside width top	400 mm
Height	438 mm
Inside length top	541 mm
Inside width top	368 mm
Inside height	400 mm

Other colours / special colours on request

Information & Service
www.bitocom



Small parts containers KLT with double base, with hinged two-part lid

KLTD64420D | Accessories

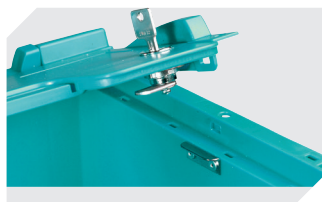

Locking systems BS
for small parts containers KLT
7-14434



Labels
W 210 x H 74 mm
43-14557



Transport dolly
polypropylene wheels
L 620 x W 420 mm
43-1491

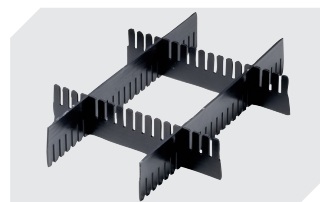

Slot-in divider strips
Material thickness 5 mm
L 1150 x H 180 mm
7-15509

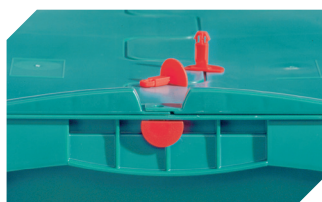

Security seals
for European size stacking containers
XL and small parts containers KLT
9-16271

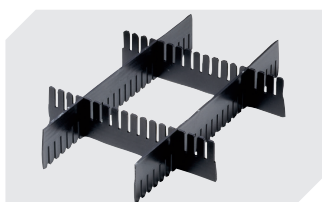

Slot-in divider strips
Material thickness 5 mm
L 1150 x H 50 mm
43-18417

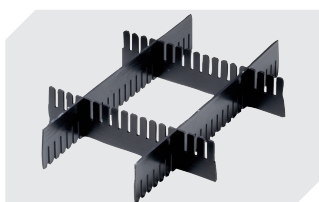

Slot-in divider strips
Material thickness 5 mm
L 1150 x H 80 mm
43-18418

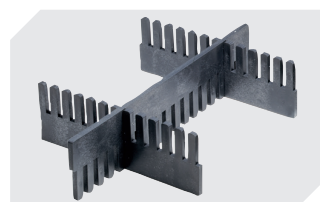

Slot-in divider strips
Material thickness 10 mm
L 950 x H 55 mm
43-18419

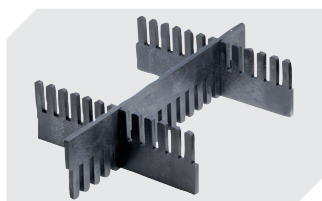

Slot-in divider strips
Material thickness 10 mm
L 950 x H 120 mm
43-18420



Covers for palletised containers
L 1220 x W 820 mm
9-18421

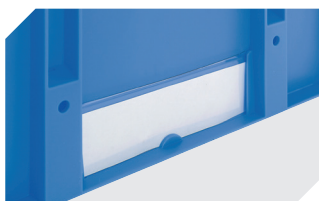

Label covers
for European size stacking containers
XL and small parts containers KLT
W 209 x H 67 mm
9-20053



Label covers
for small parts containers KLT
firm fit
W 218 x H 80 mm
9-20054



Transport dolly
rubber wheels
L 620 x W 420 mm
43-21883



Document pockets
self-adhesive
3 sides open
L 175 x W 105 mm
6-5031

Information & Service
www.bitto.com

BITO
STORAGE
SYSTEMS