

European size stacking containers XL with double base

XL86421D | Data sheet

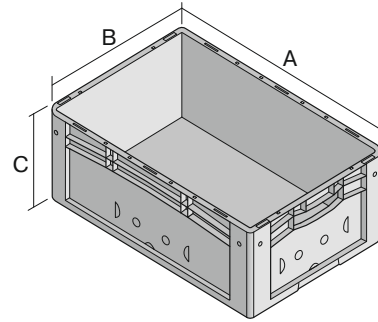

Pos.	Dimensions, Tolerances as specified in DIN 16901	
A	Outside length top	800 mm
B	Outside width top	600 mm
C	Height	420 mm

Features	*Load capacity as specified in EN 13117
Proper weight	7.36 kg
*Stacking load	800 kg
*Load capacity	200 kg
Volume	164 Litres
Warranty	5 year BITO QUALITY
ESD	ESD version upon request
Temperature range	-20°C to +60°C
Food safety	-
Material	PP
Stock item	-
Pcs/pack	1
Colour	blue
Ref. no.	43-22559

Dimensions, Tolerances as specified in DIN 16901	
Outside length top	800 mm
Outside width top	600 mm
Height	420 mm
Inside length top	762 mm
Inside width top	562 mm
Inside height	401 mm

Other colours / special colours on request

Printed message	
Pad printing area on short side (front)	100 x 180 mm
Pad printing area on short side (rear)	100 x 180 mm
Pad printing area on long side	100 x 180 mm
Hot foil printing area on short side (front)	100 x 180 mm
Hot foil printing area on short side (rear)	100 x 180 mm
Hot foil printing area on long side	100 x 180 mm
Injection mold printing area on long side	25 x 100 mm

European size stacking containers XL with double base

XL86421D | Accessories



Transport dolly
for containers sized 800 x 600 mm
L 800 x W 600 mm
43-1150



Drop-on lid
for European size stacking
containers XL
L 800 x W 600 mm
43-14853



Covers for palletised containers
L 1220 x W 820 mm
9-18421

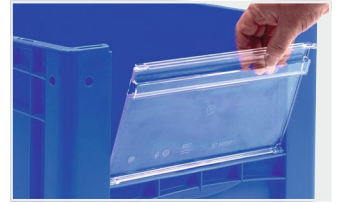

Windows
for European size stacking
containers XL
W 460 x H 198 mm
43-22548