

European size stacking containers BN, with solid sides

BN6421 | Data sheet

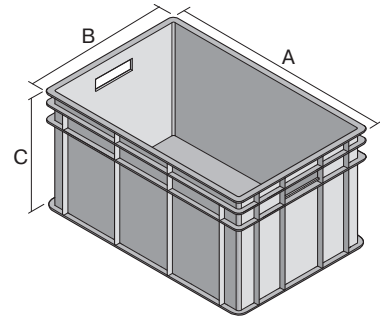

Pos. Dimensions, tolerances as specified in DIN 16901

Pos.	Dimensions, tolerances as specified in DIN 16901	
A	Outside length top	600 mm
B	Outside width top	400 mm
C	Height	215 mm

Product features

Weight	2.27 kg
*Stacking load	400 kg
*Load capacity	40 kg
Volume	42 litres
Warranty	5 year BITO QUALITY
ESD	ESD version upon request
Temperature range	-20°C to +80°C
Food safety	✓
Material	PP
Stock item	✓
Pcs/pack	1
colour	blue
Ref. no.	4-1276

Other colours / special colours on request

All written or verbal information about product properties and product application are given to the best of our knowledge. This information is based on our experience and cannot be warranted as the sole binding product properties. It is the customer's responsibility to check whether the ordered goods are suitable for the intended use. All measurements are subject to variations within the scope of the applicable manufacturing tolerances.

* Load capacity data according to EN 13117 refer to an ambient temperature of 23 °C.

Dimensions, tolerances as specified in DIN 16901

Outside length top	600 mm
Outside width top	400 mm
Height	215 mm
Inside length top	560 mm
Inside width top	360 mm
Inside height	211 mm

Information & Service
www.bitto.com

BITO
 STORAGE
 SYSTEMS

European size stacking containers BN, with solid sides

BN6421 | Accessories



Hinge clips for lids
for European size stacking containers BN
4-1144

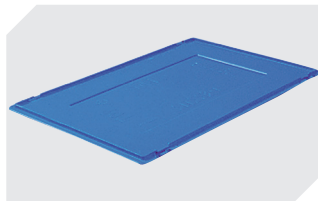

Drop-on lids
for European size stacking containers BN
L 600 x W 400 mm
4-1153



Transport dollies
polypropylene wheels
L 620 x W 420 mm
43-1491



Document clips
for European size stacking containers
L 80 x W 18 mm
4-1492



Collars
L 600 x W 400 x H 78 mm
4-1568



Grip closures
for European size stacking containers BN
4-18671



Label covers
for European size stacking containers BN
can be retro-fitted
W 110 x H 46 mm
4-9454