

Multi-purpose containers MB, with hinged interlocking lid suited for strap-sealing MBDU43221 | Data sheet

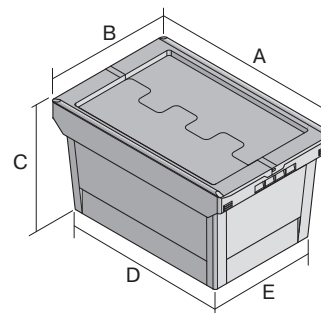

Pos. Dimensions, tolerances as specified in DIN 16901

Pos.	Dimensions, tolerances as specified in DIN 16901	
A	Outside length top	410 mm
B	Outside width top	300 mm
C	Height	249 mm
D	Base length outside	318 mm
E	Base width outside	240 mm

Product features	*Load capacity as specified in EN 13117
Weight	1.53 kg
*Stacking load	150 kg
*Load capacity	20 kg
Volume	17 litres
Warranty	5 year BITO QUALITY
ESD	ESD version upon request
Temperature range	-20°C to +80°C
Food safety	✓
Material	PP
Stock item	✓
Pcs/pack	1
colour	dove blue
Ref. no.	6-30315

Other colours / special colours on request

Dimensions, tolerances as specified in DIN 16901	
Outside length top	410 mm
Outside width top	300 mm
Height	249 mm
Inside length top	349 mm
Inside width top	271 mm
Inside length base	313 mm
Inside width base	235 mm
Inside height	210 mm

Information & Service
www.bitto.com

BITO
STORAGE
SYSTEMS

Multi-purpose containers MB, with hinged interlocking lid suited for strap-sealing

MBDU43221 | Accessories



Security seals
MBP1 - suited for BITOBOX MB
6-10810



Connector clips
6-15625



Security seals
MBP2 - suited for BITOBOX MB
6-15705



Security seals
MBP2-L - suited for BITOBOX MB,
XL, SL
6-19162



Locking clips
suited for BITOBOX MB
6-20299



Document pockets
self-adhesive
2 sides open
L 145 x W 100 mm
46-21108



Barcoded security seals
MBP3 - suited for BITOBOX MBs in all
sizes and XLs 800 x 600 mm
6-31550



Document pockets
self-adhesive
3 sides open
L 175 x W 105 mm
6-5031