

European size stacking containers XL with ribbed base RX, with hinged two-part lid XLD64271RX | Data sheet

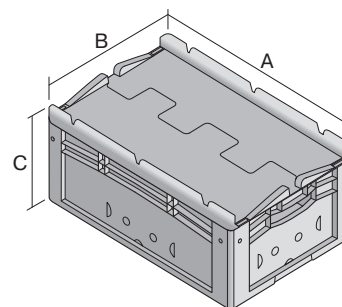

Pos. Dimensions, tolerances as specified in DIN 16901

A	Outside length top	600 mm
B	Outside width top	400 mm
C	Height	288 mm

Product features	*Load capacity as specified in EN 13117
Weight	3.47 kg
*Stacking load	300 kg
*Load capacity	50 kg
Volume	49 litres
Warranty	5 year BITO QUALITY
ESD	ESD version upon request
Temperature range	-20°C to +80°C
Food safety	✓
Material	PP
Stock item	✓
Pcs/pack	1
colour	blue
Ref. no.	43-30270

Other colours / special colours on request

Dimensions, tolerances as specified in DIN 16901	
Outside length top	600 mm
Outside width top	400 mm
Height	288 mm
Inside length top	568 mm
Inside width top	368 mm
Inside length base	559 mm
Inside width base	359 mm
Inside height	252 mm

Printed message	
Pad printing area on short side (front)	90 x 250 mm
Pad printing area on short side (rear)	90 x 250 mm
Pad printing area on long side	90 x 250 mm
Hot foil printing area on short side (front)	90 x 250 mm
Hot foil printing area on short side (rear)	90 x 250 mm
Hot foil printing area on long side	90 x 250 mm
Injection mold printing area on long side	25 x 180 mm

Information & Service
www.bito.com

BITO
LAGERTECHNIK

European size stacking containers XL with ribbed base RX, with hinged two-part lid XLD64271RX | Accessories



Security seals

for European size stacking containers XL
and small parts containers KLT
9-16271



Covers for palletised loads

L 1220 x W 820 mm
9-18421



Transport dollies

rubber wheels
L 620 x W 420 mm
43-21883



Grip closures

for European size stacking containers XL
with a height of 170, 220 and 270 mm
43-31450