

Multi-purpose containers MB - Mail custom solution, with hinged two-part lid

MBD64271POST | Data sheet

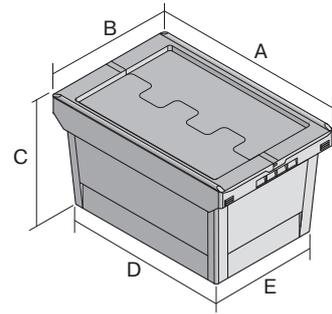

Pos. Dimensions, tolerances as specified in DIN 16901

Pos.	Dimensions, tolerances as specified in DIN 16901	
A	Outside length top	610 mm
B	Outside width top	400 mm
C	Height	290 mm
D	Base length outside	505 mm
E	Base width outside	335 mm

Product features	*Load capacity as specified in EN 13117
Weight	3.13 kg
*Load capacity	30 kg
Volume	47 litres
ESD	No
Food safety	-
Material	PP
Stock item	✓
Pcs/pack	1
colour	daffodil yellow
Ref. no.	6-17267

Other colours / special colours on request

Dimensions, tolerances as specified in DIN 16901	
Outside length top	610 mm
Outside width top	400 mm
Height	290 mm
Inside length top	540 mm
Inside width top	371 mm
Inside length base	498 mm
Inside width base	329 mm

Information & Service
www.bitto.com

BITO
 STORAGE
 SYSTEMS

Multi-purpose containers MB - Mail custom solution, with hinged two-part lid

MBD64271POST | Accessories



Security seals

MBP1 - suited for BITOBOX MB
6-10810



Transport dolly

for multi-purpose containers sized
600 x 400 mm
L 620 x W 420 mm
6-15510



Locking clips

suited for BITOBOX MB
6-20299



Barcoded security seals

MBP3 - suited for BITOBOX MBs in all
sizes and XLs 800 x 600 mm
6-31550