

European size stacking containers XL with double base

XL64321D | Data sheet

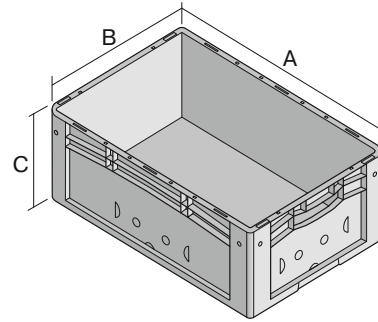

Pos.	Dimensions, Tolerances as specified in DIN 16901	
A	Outside length top	600 mm
B	Outside width top	400 mm
C	Height	320 mm

Features	*Load capacity as specified in EN 13117
Proper weight	3.04 kg
*Stacking load	300 kg
*Load capacity	100 kg
Volume	60 Litres
Warranty	5 year BITO QUALITY
ESD	ESD version upon request
Temperature range	-20°C to +60°C
Food safety	-
Material	PP
Stock item	-
Pcs/pack	1
Colour	blue
Ref. no.	43-18707

Dimensions, Tolerances as specified in DIN 16901	
Outside length top	600 mm
Outside width top	400 mm
Height	320 mm
Inside length top	568 mm
Inside width top	368 mm
Inside length base	559 mm
Inside width base	359 mm
Inside height	302 mm

Other colours / special colours on request

Printed message	
Pad printing area on short side (front)	100 x 250 mm
Pad printing area on short side (rear)	100 x 250 mm
Pad printing area on long side	100 x 250 mm
Hot foil printing area on short side (front)	100 x 250 mm
Hot foil printing area on short side (rear)	100 x 250 mm
Hot foil printing area on long side	100 x 250 mm
Injection mold printing area on long side	100 x 250 mm

European size stacking containers XL with double base

XL64321D | Accessories



Covers for palletised containers
L 1220 x W 820 mm
9-18421



Drop-on lids
for European size stacking
containers XL
L 600 x W 400 mm
43-20301



Drop-on lids
for European size stacking
containers XL
L 600 x W 400 mm
43-20494



Transport dolly
rubber wheels
L 620 x W 420 mm
43-21883

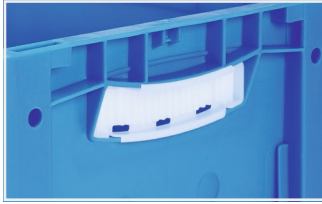

Grip closures
suited for bins with a height of 320
and 420 mm
43-31448