

Multi-purpose containers MB, for hazardous substances, drop-on lid with metal snap locks

MBSG64221CLIP | Data sheet

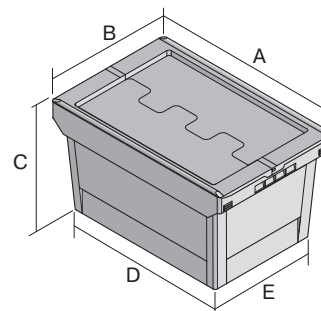

Pos. Dimensions, tolerances as specified in DIN 16901

Pos.	Dimensions, tolerances as specified in DIN 16901	
A	Outside length top	610 mm
B	Outside width top	410 mm
C	Height	238 mm
D	Base length outside	505 mm
E	Base width outside	335 mm

Product features	*Load capacity as specified in EN 13117
Weight	3.00 kg
*Load capacity	17 kg
Volume	38 litres
ESD	No
Food safety	-
Material	PP
Stock item	✓
Pcs/pack	1
colour	purple red
Ref. no.	6-18657

Other colours / special colours on request

Dimensions, tolerances as specified in DIN 16901	
Outside length top	610 mm
Outside width top	410 mm
Height	238 mm
Inside length top	540 mm
Inside width top	371 mm
Inside length base	498 mm
Inside width base	329 mm

Information & Service
www.bitto.com

BITO
STORAGE
SYSTEMS

Multi-purpose containers MB, for hazardous substances, drop-on lid with metal snap locks

MBSG64221CLIP | Accessories

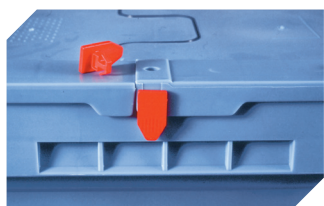

Security seals

MBP1 - suited for BITOBOX MB
6-10810

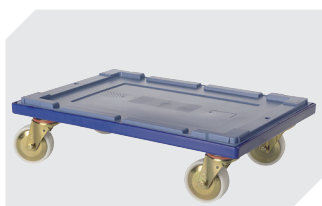

Transport dolly

for multi-purpose containers sized
600 x 400 mm
L 620 x W 420 mm
6-15510

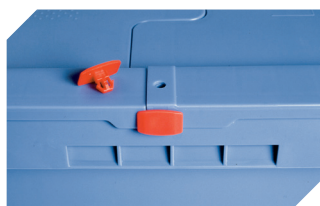

Security seals

MBP2 - suited for BITOBOX MB
6-15705



Security seals

MBP2-L - suited for BITOBOX MB,
XL, SL
6-19162



Locking clips

suited for BITOBOX MB
6-20299



Barcoded security seals

MBP3 - suited for BITOBOX MBs in all
sizes and XLs 800 x 600 mm
6-31550