

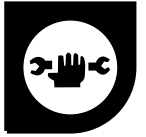

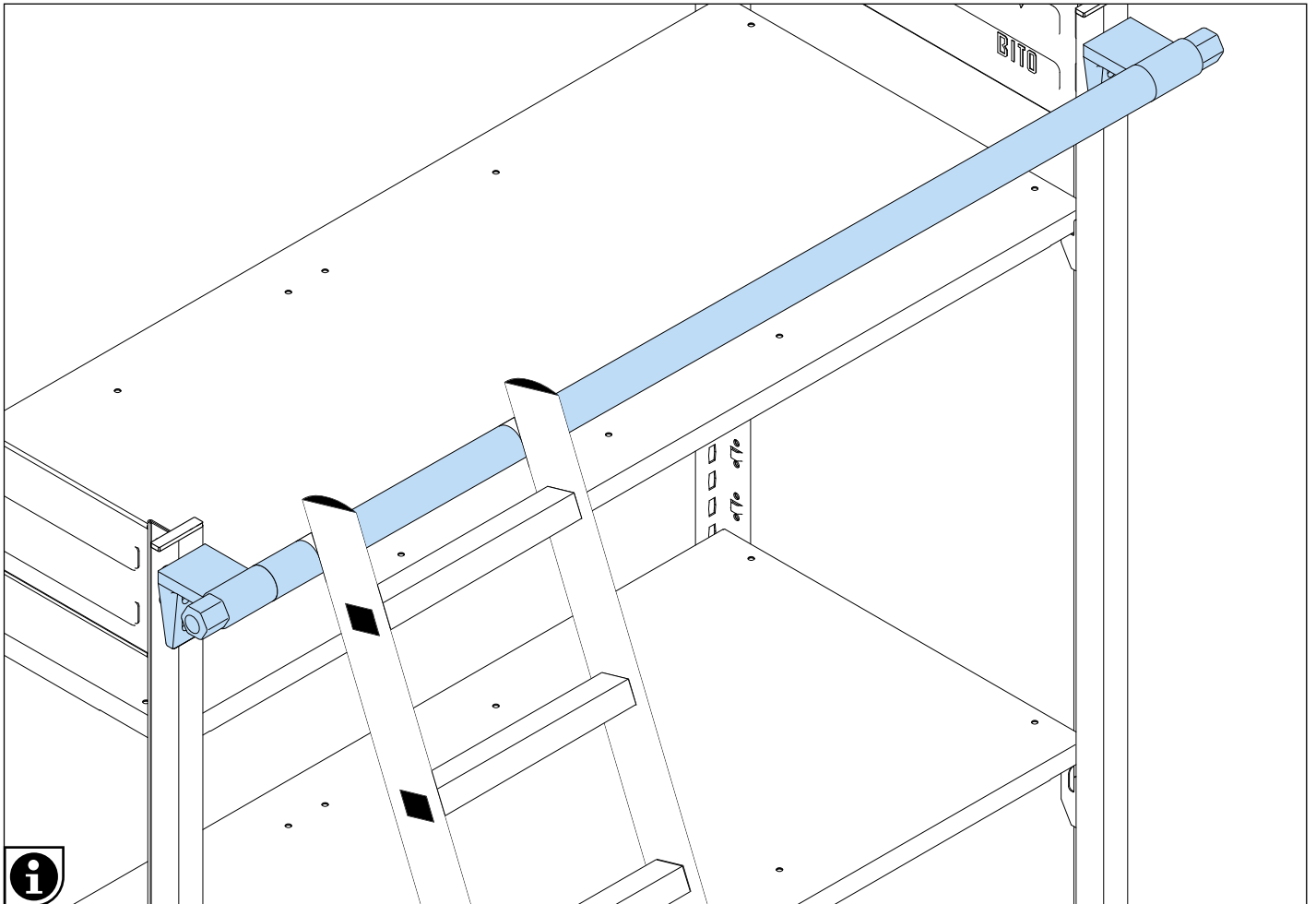

Leiterschiene

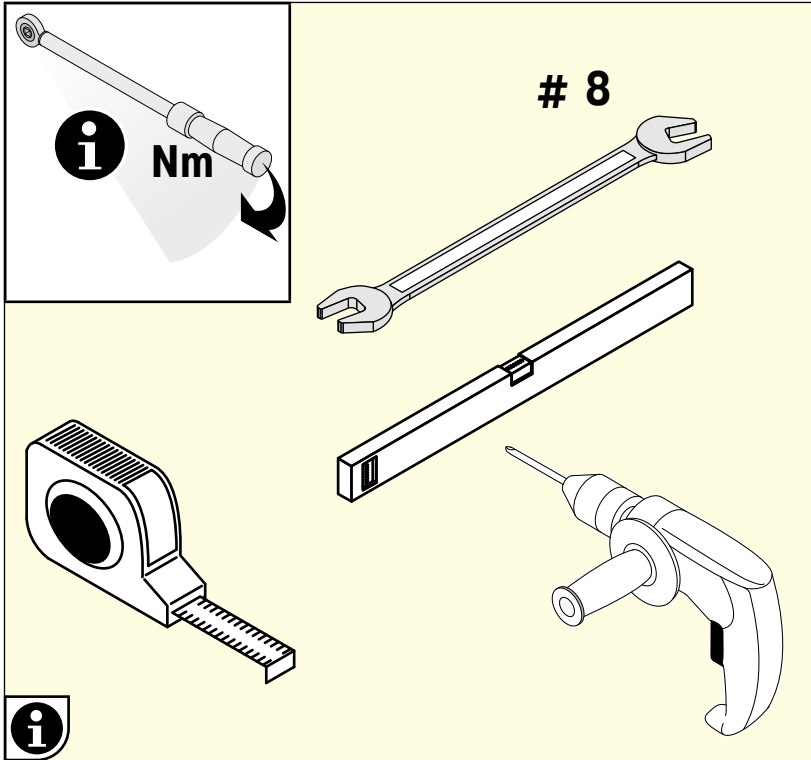

Rail conducteur



LEITERSCHIENE | RAIL CONDUCTEUR

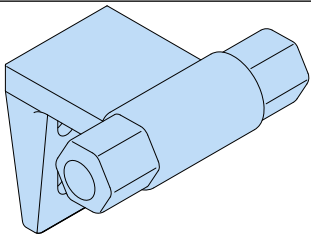

	i		
①	40531	ISO 7093-1-8-200 HV 	4x
②	40531	DIN ISO 10511 M8 	2x
③	40530		2x

	i		
④	40531	ISO 4017 - M8 x 40 	8.8 2x

