

Multi-purpose containers MB, with hinged two-part lid

MBD86421 | Data sheet

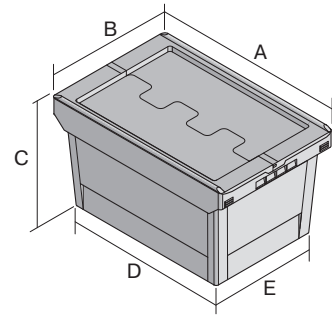

Pos. Dimensions, tolerances as specified in DIN 16901

Pos.	Dimensions, tolerances as specified in DIN 16901	
A	Outside length top	800 mm
B	Outside width top	600 mm
C	Height	423 mm
D	Base length outside	690 mm
E	Base width outside	508 mm

Product features	*Load capacity as specified in EN 13117
Weight	8.35 kg
*Stacking load	300 kg
*Load capacity	50 kg
Volume	154 litres
Warranty	5 year BITO QUALITY
ESD	ESD version upon request
Temperature range	-20°C to +80°C
Food safety	✓
Material	PP
Stock item	✓
Pcs/pallet	30
Pcs/pack	1
colour	dove blue
Ref. no.	6-15258

Other colours / special colours on request

Dimensions, tolerances as specified in DIN 16901	
Outside length top	800 mm
Outside width top	600 mm
Height	423 mm
Inside length top	742 mm
Inside width top	560 mm
Inside length base	682 mm
Inside width base	500 mm
Inside height	418 mm
Height of stacking rim	70 mm

Printed message	
Pad printing area on short side (front)	250 x 100 mm
Pad printing area on short side (rear)	250 x 100 mm
Pad printing area on long side	250 x 100 mm
Screen printing area on short side	430 x 210 mm
Screen printing area on short side (rear)	430 x 210 mm
Screen printing area on long side	600 x 200 mm
Hot foil printing area on short side (front)	250 x 100 mm
Hot foil printing area on short side (rear)	250 x 100 mm
Hot foil printing area on long side	250 x 100 mm
Injection mold printing area on long side	225 x 95 mm

Information & Service
www.bitto.com

BITO
 STORAGE
 SYSTEMS

Multi-purpose containers MB, with hinged two-part lid

MBD86421 | Accessories



Security seals
MBP1 - suited for BITOBOX MB
6-10810

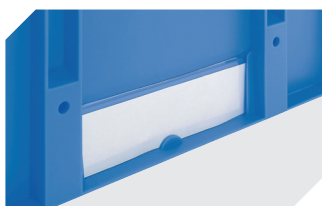

Label covers
for multi-purpose containers MB
W 60 x H 80.4 mm
6-15244



Connector clips
6-15625



Security seals
MBP2 - suited for BITOBOX MB
6-15705



Security seals
MBP2-L - suited for BITOBOX MB,
XL, SL
6-19162



Transport dollies
for multi-purpose containers sized
800 x 400 mm and 800 x 600 mm
L 720 x W 540 mm
6-19439

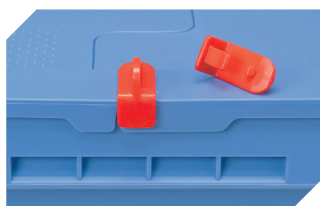

Locking clips
suited for BITOBOX MB
6-20299

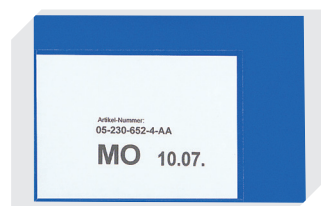

Document pockets
self-adhesive
2 sides open
L 145 x W 100 mm
46-21108



Barcoded security seals
MBP3 - suited for BITOBOX MBs in all
sizes and XLs 800 x 600 mm
6-31550



Document pockets
self-adhesive
3 sides open
L 175 x W 105 mm
6-5031