

European size stacking containers XL, with one-piece hinged lid

XLD21121 | Data sheet

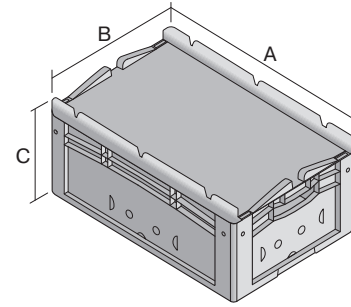

Pos. Dimensions, tolerances as specified in DIN 16901

Pos.	Dimensions, tolerances as specified in DIN 16901	
A	Outside length top	200 mm
B	Outside width top	150 mm
C	Height	138 mm

Product features	*Load capacity as specified in EN 13117
Weight	0.40 kg
*Load capacity	10 kg
Volume	1.6 litres
Warranty	5 year BITO QUALITY
ESD	ESD version upon request
Temperature range	-20°C to +90°C
Food safety	✓
Material	PP
Stock item	✓
Pcs/pack	1
colour	blue
Ref. no.	43-14294

Other colours / special colours on request

Dimensions, tolerances as specified in DIN 16901	
Outside length top	200 mm
Outside width top	150 mm
Height	138 mm
Inside length top	168 mm
Inside width top	118 mm
Inside length base	126 mm
Inside width base	106 mm
Inside height	117 mm

Printed message

Pad printing area on short side (front)	40 x 70 mm
Pad printing area on short side (rear)	40 x 70 mm
Hot foil printing area on short side (front)	40 x 70 mm
Hot foil printing area on long side	40 x 70 mm
Injection mold printing area on long side	20 x 105 mm

Information & Service
www.bito.com

BITO
 LAGERTECHNIK

European size stacking containers XL, with one-piece hinged lid
XLD21121 | Accessories



Covers for palletised loads

L 1220 x W 820 mm

9-18421

Information & Service
www.bito.com

BITO
LAGERTECHNIK